

LOLA® VERTICALE

INOX DECOR X03 | INOX DECOR X04

artwork **Mariano Moroni**



3D
TRADEMARK

GARANZIA 15 ANNI

MATERIALI:

Collettori orizzontali in acciaio inox lucido/satinato \varnothing 38 mm.
Corpi radianti curvati in acciaio inox lucido/satinato 30x10 mm.

KIT DI FISSAGGIO:

Supporti, valvolino di sfogo, chiave esagonale, tasselli e viti per fissaggio idonei per impiego su pareti compatte o in laterizio forato, istruzioni di montaggio. Il kit è conforme alla norma VDI 6036 - classe 4.

IMBALLO:

Il radiatore viene protetto con film di polietilene termoretraibile riciclabile e confezionato in scatola di cartone. Istruzioni uso e manutenzione a corredo.

PARTICOLARITÀ:

Acciaio inox austenitico ad elevata resistenza alla corrosione. Affidabilità ed estetica garantite nel tempo. Rese termiche certificate presso i laboratori accreditati secondo la norma EN442.

CERTIFICAZIONI



Pressione max: 8 bar

Temperatura massima d'esercizio: 110° C

Funzionamento: acqua calda

Conessioni: n° 2 da 1/2" G - n° 1 da 1/8" G

AWARD

GOLD VILLA
AWARD

LOLA® DECOR X03

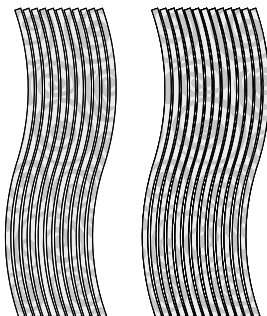

LOLA® DECOR X04

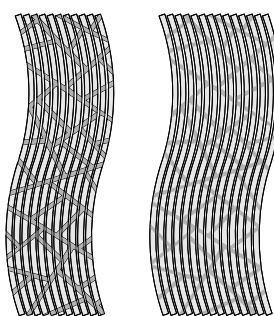

ACCESSORI



Valvola elegant a squadra manuale lucida

Attacco Rame \varnothing 12/14/15
Codice 5991990301084

Attacco Multistrato \varnothing 16 x2
Codice 5991990301083



Valvola elegant int. 50 a squadra con testa termostatica dx lucida

Attacco Rame \varnothing 12/14/15
Codice 5991990301076

Attacco Multistrato \varnothing 16 x2
Codice 5991990301075



2 appendiabiti inox lucidi

Codice 5991990010223

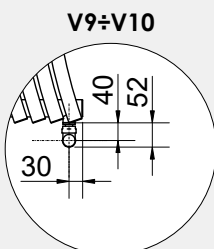

V9÷V10

Misure per valvola elegant a squadra manuale

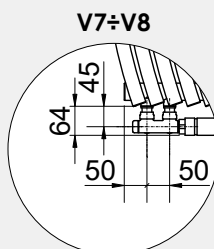

V7÷V8

Misure per valvola elegant interasse 50 mm a squadra dx con testa termostatica

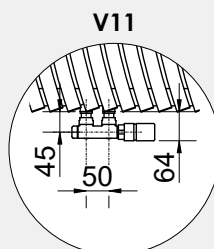

V11



Kit copritubo per valvole lucide

Codice 5103000000044

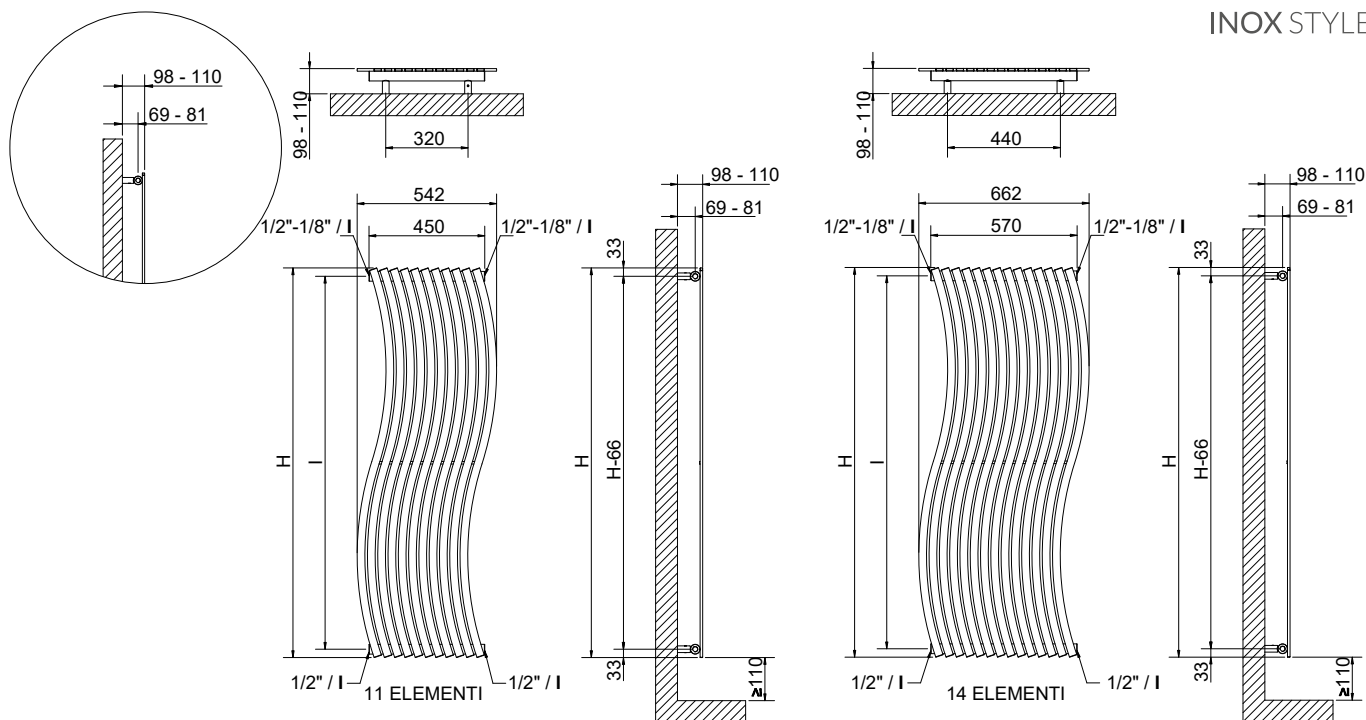

Allacciamenti

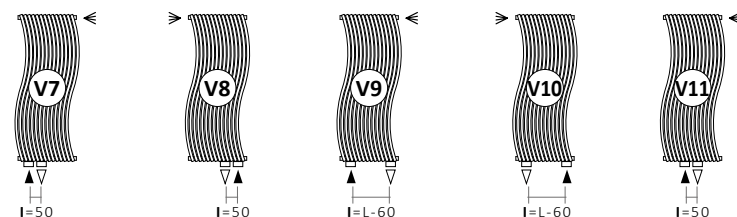
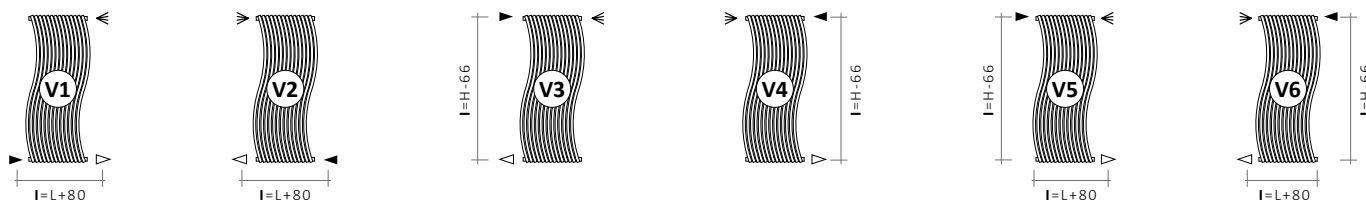

Allacciamenti su misura

Indicare l'interasse X



Specificare sempre in sede di ordine il tipo di allacciamento (da V1 a V11).

Legenda connessioni = ► entrata ◄ uscita ◀ sfogo H altezza I interasse L larghezza □ manicotto

LOLA® DECOR VERTICALE

Variante	INOX DECOR X03			INOX DECOR X04			Peso a vuoto [Kg]	Sup. [m ²]	Cont. d'acqua [lt]	Potenza termica Watt		Esponente n
	Altezza H [mm]	Larghezza L [mm]	Interasse I [mm]	Codice	Codice	Δt = 50°C				Δt = 30°C		
V1	1516	450	530	3551740130101	3551740130103	15,5	1,45	4,1	507	264	1,2746	
		570	650	3551740130102	3551740130104	19,0	1,84	5,1	645	334	1,2878	
V2	1516	450	530	3551740000075	3551740130105	15,5	1,45	4,1	507	264	1,2746	
		570	650	3551740000034	3551740130106	19,0	1,84	5,1	645	334	1,2878	
V3	1516	450	1450	3551740000003	3551740130107	15,5	1,45	4,1	507	264	1,2746	
		570	1450	3551740000031	3551740130108	19,0	1,84	5,1	645	334	1,2878	
V4	1516	450	1450	3551740000043	3551740130109	15,5	1,45	4,1	507	264	1,2746	
		570	1450	3551740000032	3551740130110	19,0	1,84	5,1	645	334	1,2878	
V5	1516	450	-	3551740000079	3551740130111	15,5	1,45	4,1	507	264	1,2746	
		570	-	3551740000081	3551740130112	19,0	1,84	5,1	645	334	1,2878	
V6	1516	450	-	3551740000110	3551740130113	15,5	1,45	4,1	507	264	1,2746	
		570	-	3551740000111	3551740130114	19,0	1,84	5,1	645	334	1,2878	
V7	1516	450	50	3551740000076	3551740130115	15,5	1,45	4,1	507	264	1,2746	
		570	50	3551740000071	3551740130116	19,0	1,84	5,1	645	334	1,2878	
V8	1516	450	50	3551740000045	3551740130117	15,5	1,45	4,1	507	264	1,2746	
		570	50	3551740000084	3551740130118	19,0	1,84	5,1	645	334	1,2878	
V9	1516	450	390	3551740000046	3551740130119	15,5	1,45	4,1	507	264	1,2746	
		570	510	3551740000028	3551740130120	19,0	1,84	5,1	645	334	1,2878	
V10	1516	450	390	3551740000065	3551740130121	15,5	1,45	4,1	507	264	1,2746	
		570	510	3551740000060	3551740130122	19,0	1,84	5,1	645	334	1,2878	
V11	1516	450	50	3551740000026	3551740130123	15,5	1,45	4,1	507	264	1,2746	
		570	50	3551740000086	3551740130124	19,0	1,84	5,1	645	334	1,2878	

Per Δt diversi da 50 utilizzare la seguente formula: resa ricercata = resa termica a Δt 50 x (Δt desiderato/50)ⁿ