

- Versioni Acqua Calda
- Hot Water Versions
- Versions d'eau chaude
- Warmwasserbetrieb
- Versiones de agua caliente

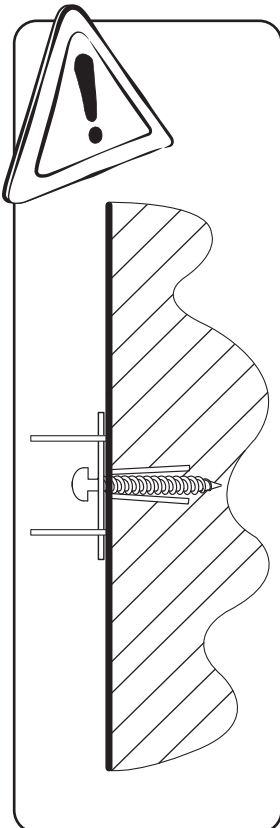

- I sistemi di fissaggio (viti + tasselli) sono idonei per impiego su pareti compatte o in laterizio forato. Per pareti in materiali diversi è responsabilità dell'installatore adottare sistemi di fissaggi appropriati.
- The fixing kits (screws +dowels) are suitable for compact wall or hollow bricks. For wall in different materials it is responsibility of the installer to use appropriate fixing.
- Les systèmes de fixation (vis + chevilles) sont aptes à être utiliser sur des parois compactes ou en briques creuses. Pour des parois avec des matériaux différents, la responsabilité sera de l'installateur qui devra utiliser des systèmes de fixation appropriés.
- Die Verbindungselemente (Schrauben + Dübel) sind für den Einsatz in kompakten oder hohlen Ziegelmauern. Bei Einsatz in unterschiedliche Materialien liegt in der Verantwortung des Installateurs geeignete Verbindungselemente einzusetzen.
- Los sistemas de fijación (tornillos + tacos) son adecuados para uso en paredes compactas o de ladrillo hueco. Para paredes de material diferente el instalador debe adoptar los sistemas de fijación pertinentes.

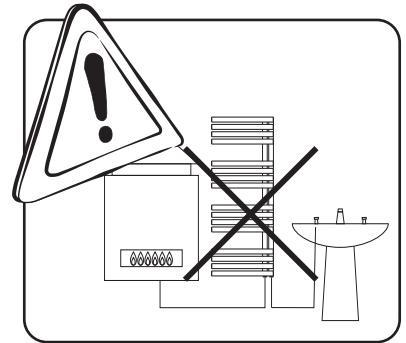
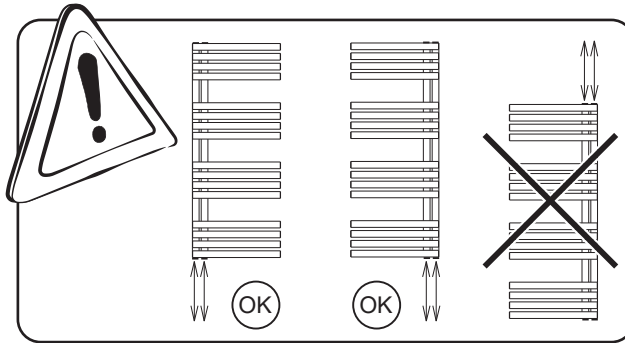
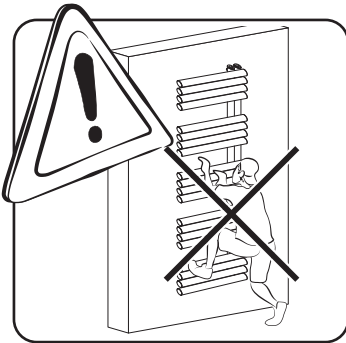
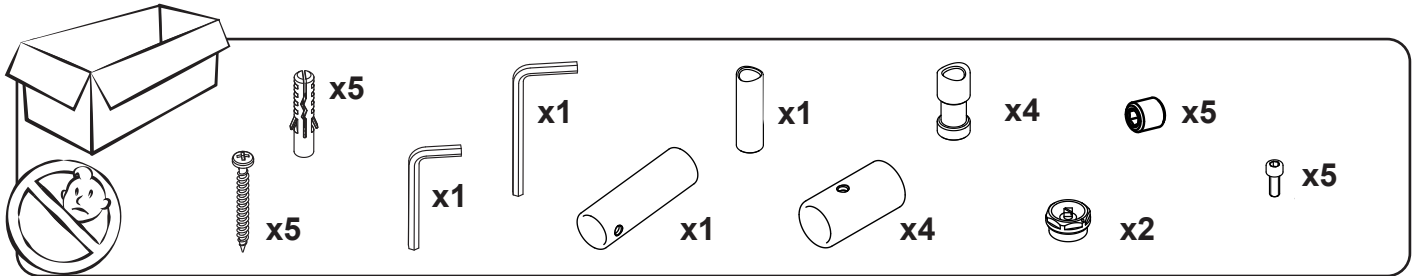

1

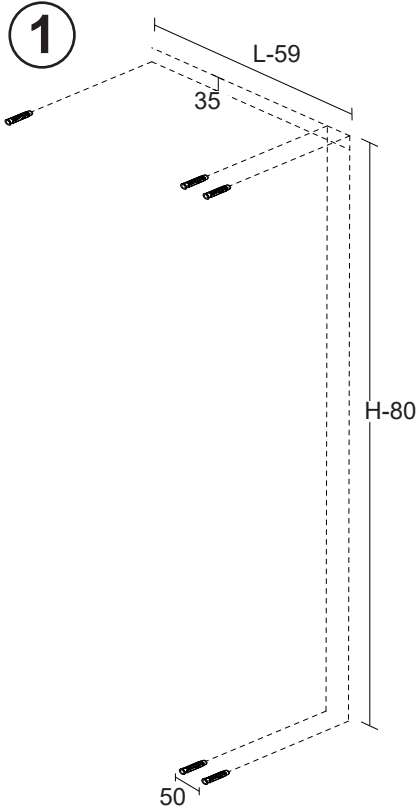

2

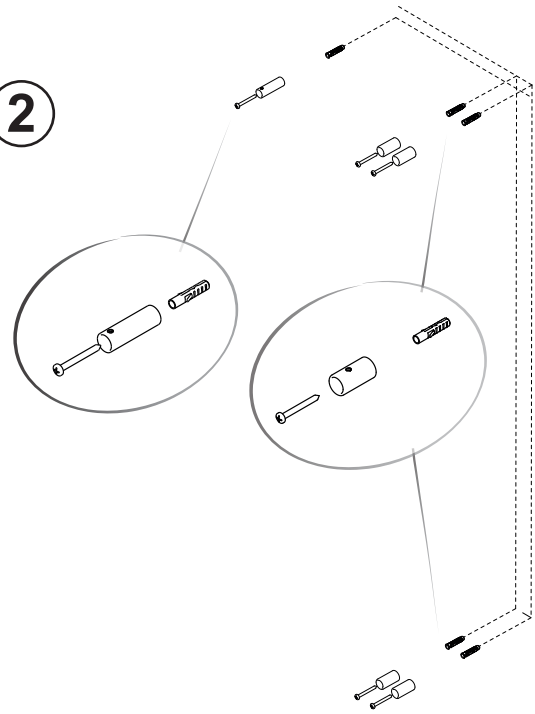

3

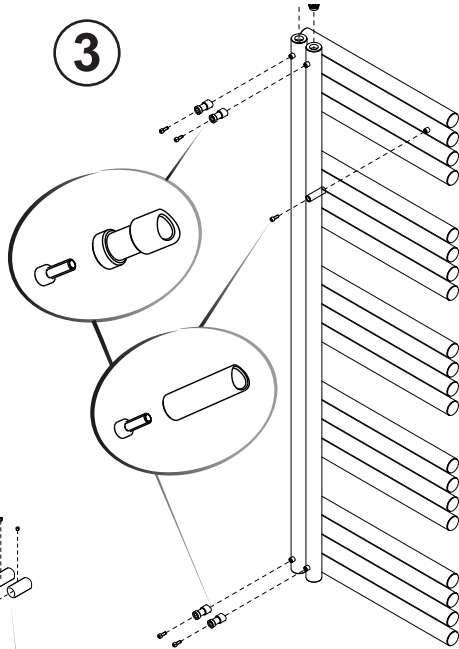

4

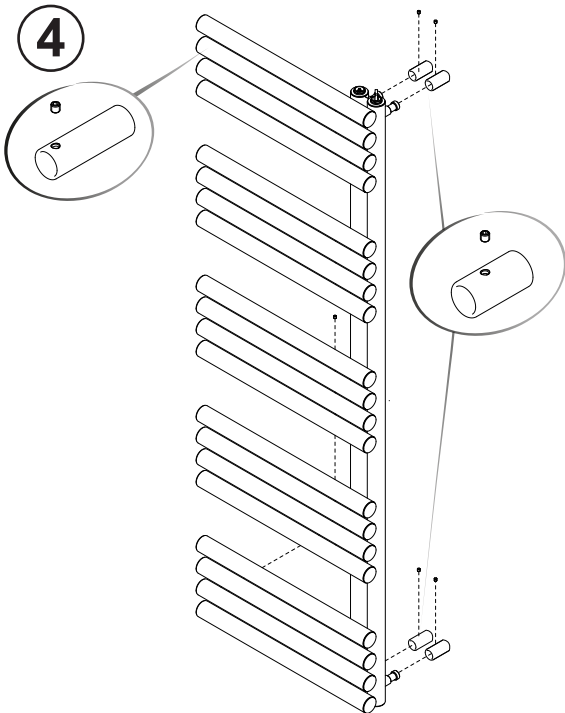

5

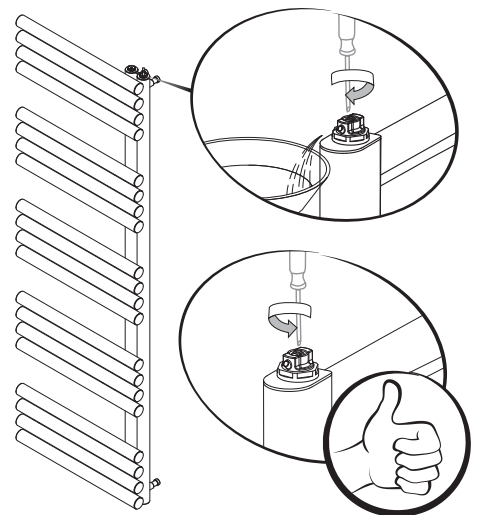

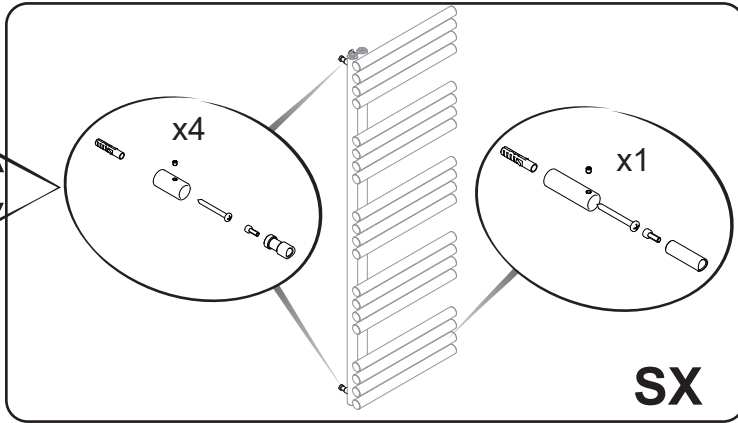

- Versioni Acqua Calda
- Hot Water Versions
- Versions d'eau chaude
- Warmwasserbetrieb
- Versiones de agua caliente

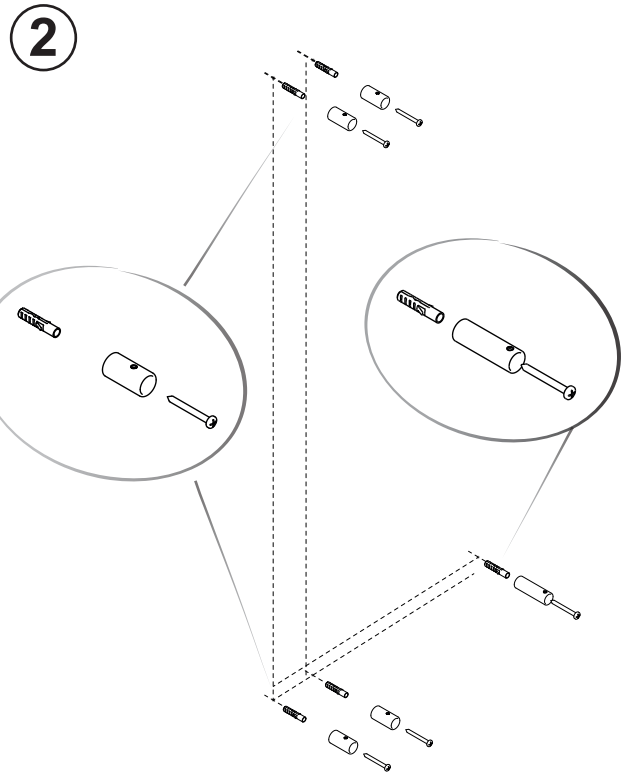
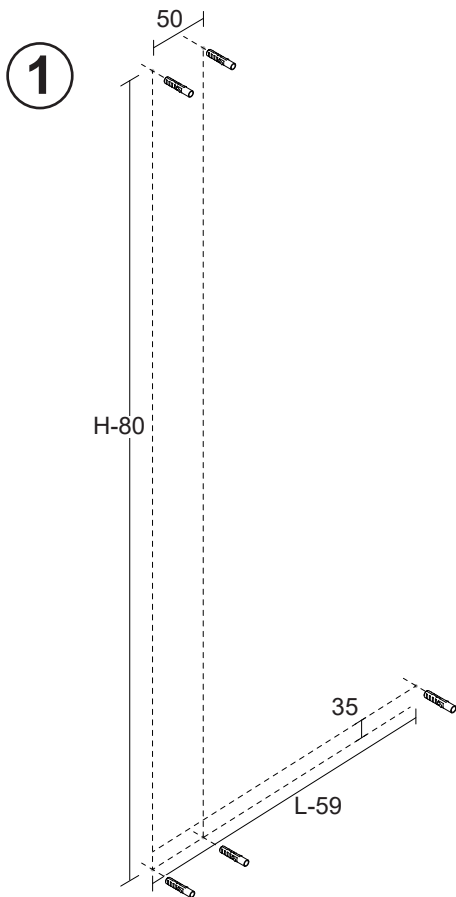
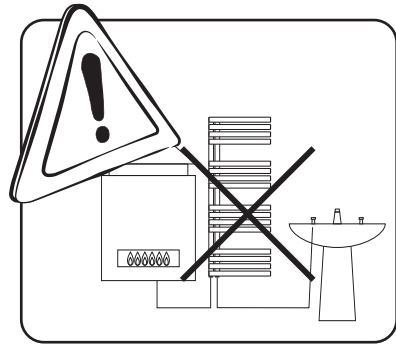
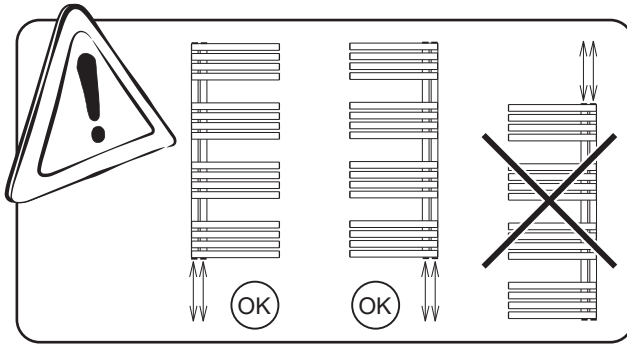
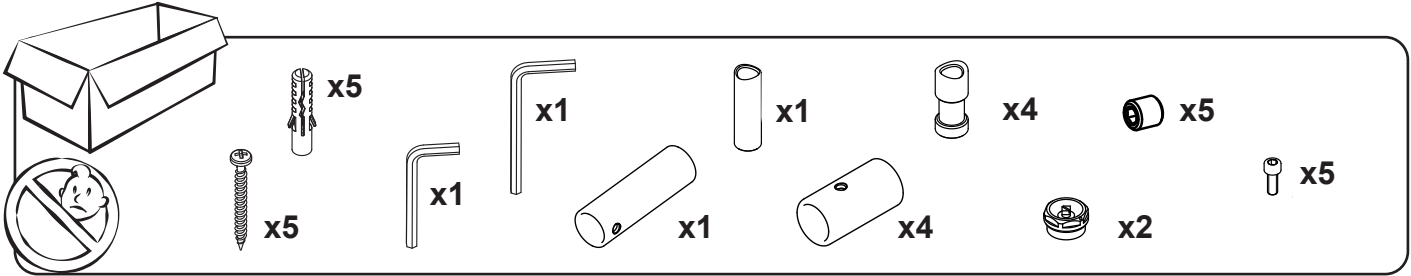



3

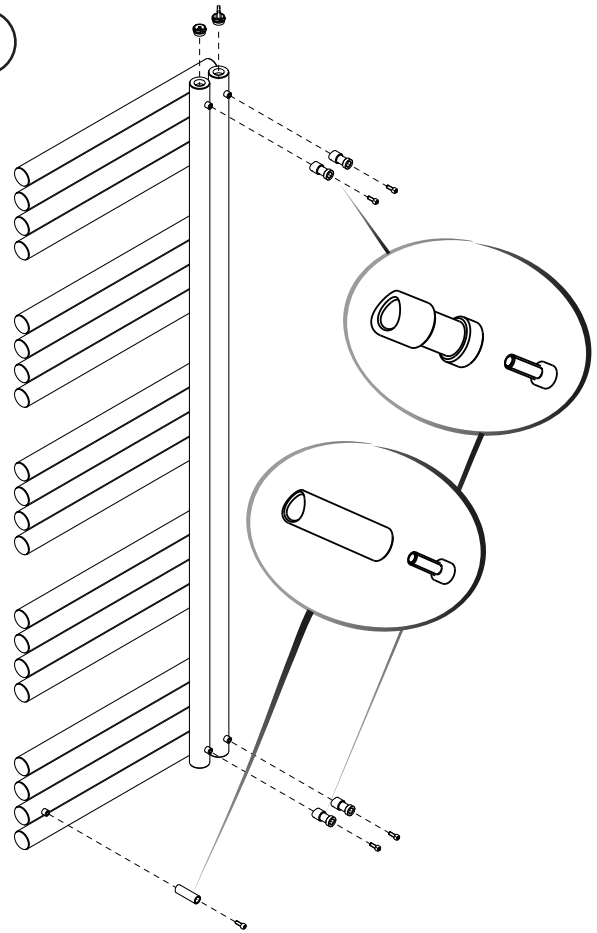

4

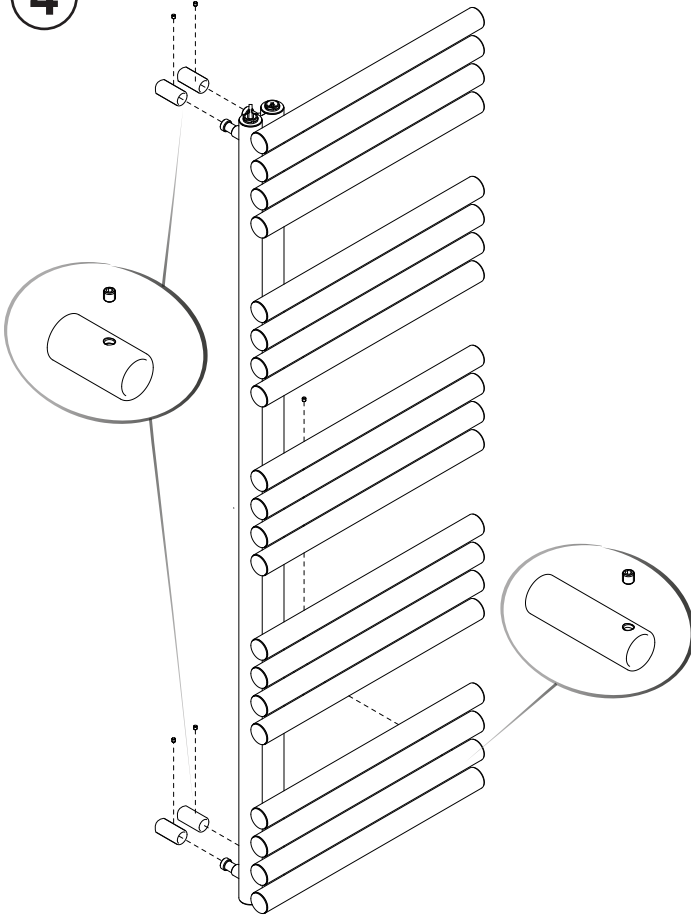

5

